



DX225LC TECHNICAL DATA





GENERAL SPECIFICATIONS

	ITEMS	UNIT	STANDARD
ENGINE	MODEL		Doosan DL06
	NUMBER OF CYLINDERS		6
	RATED FLYWHEEL POWER (hp PER SAE J1995) GROSS	hp / rpm	155 / 1,900
		kW / rpm	115 / 1,900
	RATED FLYWHEEL POWER (hp PER SAE J1349) NET	hp / rpm	148 / 1,900
		kW / rpm	110 / 1,900
	MAXIMUM TORQUE (GROSS) (SAE J1995)	ft lb / rpm	506 / 1,400
		Nm / rpm	686 / 1,400
	PISTON DISPLACEMENT	in ³	359
		cc	5,890
	BORE AND STROKE	in x in	3.9 x 4.9
mm x mm		100 x 125	
STARTER	V / kW	24 V, 4.5 kW	
BATTERIES	V / AH	2 x 12 V x 100 AH	
AIR CLEANER		Double element with auto dust evacuation.	
MAIN PUMPS – 2 VARIABLE DISPLACEMENT AXIAL PISTON PUMPS MAX FLOW	US gpm	2 x 55	
	L/min	2 x 206.5	
PILOT PUMP (GEAR DESIGN)	MAXIMUM FLOW	US gpm	7.5
		L/min	28.5
	RELIEF PRESSURE	psi	569
		bar	39
MAXIMUM SYSTEM PRESSURE	BOOM/ARM/BUCKET (NORMAL MODE)	psi	4,694
		bar	324
	BOOM/ARM/BUCKET (POWER MODE)	psi	4,978
		bar	343
	TRAVEL	psi	4,694
		bar	324
SWING	psi	3,840	
	bar	265	
UNDERCARRIAGE	UPPER ROLLERS		2 each track (STD. Shoes)
	LOWER ROLLERS		9 each track
	NUMBER OF SHOES (LINKS PER SIDE)		49 each track (Triple Grouser)
	TOTAL LENGTH OF TRACK	ft in	14'7"
mm		4,445	
ENVIRONMENT	SOUND LEVEL (2000/14/EC)	dB(A)	103
	CABIN SOUND LEVEL (ISO 6396)	dB(A)	73
SWING MECHANISM	SWING SPEED	rpm	0 – 11.0
DRIVE SYSTEM	TRAVEL SPEED (FAST/SLOW)	MPH	3.4/1.9
		km/h	5.5/3.0
	DRAWBAR PULL	lb	48,943
		kg	22,200
	MAXIMUM GRADE	%	70
	°	35	

DX225LC

ITEMS		UNIT	STANDARD
REFILL CAPACITIES	FUEL TANK	US gal	105.7
		L	400
	COOLING SYSTEM (RADIATOR CAPACITY)	qt	25.2
		L	24
	ENGINE OIL	qt	28.4
		L	27
	SWING DRIVE	qt	5.3
		L	5
	FINAL DRIVE (EACH SIDE)	qt	5.7
		L	5.4
	HYDRAULIC SYSTEM	US gal	87
		L	330
	HYDRAULIC TANK	US gal	63.4
		L	240

WEIGHT

BOOM	18'8" (5.7 m)	
ARM	9'6" (2.9 m)	
BUCKET	1.20 yd ³ (0.92 m ³)	
SHOE WIDTH (TRIPLE GROUSER)	OPERATING WEIGHT	GROUND PRESSURE
2'0" (600 mm)	47,399 lb (21,500 kg)	6.40 psi (0.441 bar)
2'4" (700 mm)	48,061 lb (21,800 kg)	5.69 psi (0.392 bar)
2'8" (800 mm)	48,722 lb (22,100 kg)	4.98 psi (0.343 bar)
2'11" (900 mm)	49,384 lb (22,400 kg)	4.41 psi (0.304 bar)

HYDRAULIC CYLINDERS

The piston rods and cylinder bodies are made of high-strength steel. A shock absorbing mechanism is fitted in all cylinders to ensure shock-free operation and extend piston life.		
CYLINDERS	QUANTITY	BORE x ROD DIAMETER x STROKE
BOOM	2	4.9" x 3.3" x 4'2" (125 x 85 x 1,260 mm)
ARM	1	5.5" x 3.9" x 4'9" (140 x 100 x 1,450 mm)
BUCKET	1	4.7" x 3.1" x 3'6" (120 x 80 x 1,060 mm)



BUCKET

CAPACITY		WIDTH		WEIGHT	RECOMMENDATIONS		
SAE, HEAPED	CECE, HEAPED	WITHOUT SIDE CUTTERS	WITH SIDE CUTTERS		18'8" (5,700 mm) BOOM		
					7'10" (2,400 mm) ARM	9'6" (2,900 mm) ARM	11'6" (3,500 mm) ARM
0.67 yd ³ (0.51 m ³)	0.61 yd ³ (0.47 m ³)	2'4" (722 mm)	2'6" (772 mm)	1,168 lb (530 kg)	A	A	A
1.06 yd ³ (0.81 m ³)	0.94 yd ³ (0.72 m ³)	3'6" (1,064 mm)	3'8" (1,126 mm)	1,442 lb (654 kg)	A	A	B
1.20 yd ³ (0.92 m ³)	1.06 yd ³ (0.81 m ³)	3'10" (1,172 mm)	4'1" (1,236 mm)	1,565 lb (710 kg)	A	B	C
1.37 yd ³ (1.05 m ³)	1.20 yd ³ (0.92 m ³)	4'3" (1,308 mm)	4'6" (1,370 mm)	1,631 lb (740 kg)	B	C	-
1.53 yd ³ (1.17 m ³)	1.31 yd ³ (1.0 m ³)	4'8" (1,428 mm)	4'11" (1,491 mm)	1,753 lb (795 kg)	C	-	-
1.67 yd ³ (1.28 m ³)	1.45 yd ³ (1.11 m ³)	5'1" (1,542 mm)	5'3" (1,605 mm)	1,830 lb (830 kg)	-	-	-

A. Suitable for materials with density of 3,370 lb/yd³ (2,000 kg•m³) or less

B. Suitable for materials with density of 2,700 lb/yd³ (1,600 kg•m³) or less

C. Suitable for materials with density of 1,850 lb/yd³ (1,100 kg•m³) or less

DIGGING FORCE (ISO)

BUCKET (PCSA)	0.67 yd ³ (0.51 m ³)	1.06 yd ³ (0.81 m ³)	1.20 yd ³ (0.92 m ³)	1.37 yd ³ (1.05 m ³)	1.53 yd ³ (1.17 m ³)	1.67 yd ³ (1.28 m ³)
DIGGING FORCE	33,510 lbf	33,510 lbf	33,510 lbf	33,510 lbf	33,510 lbf	33,510 lbf
	15,200 kgf	15,200 kgf	15,200 kgf	15,200 kgf	15,200 kgf	15,200 kgf
	149 kN	149 kN	149 kN	149 kN	149 kN	149 kN

ARM	7'10" (2,400 mm)	9'6" (2,900 mm)	11'6" (3,500 mm)
DIGGING FORCE	27,778 lbf	23,810 lbf	21,385 lbf
	12,600 kgf	10,800 kgf	9,700 kgf
	124 kN	106 kN	95 kN

DX225LC

DIMENSIONS

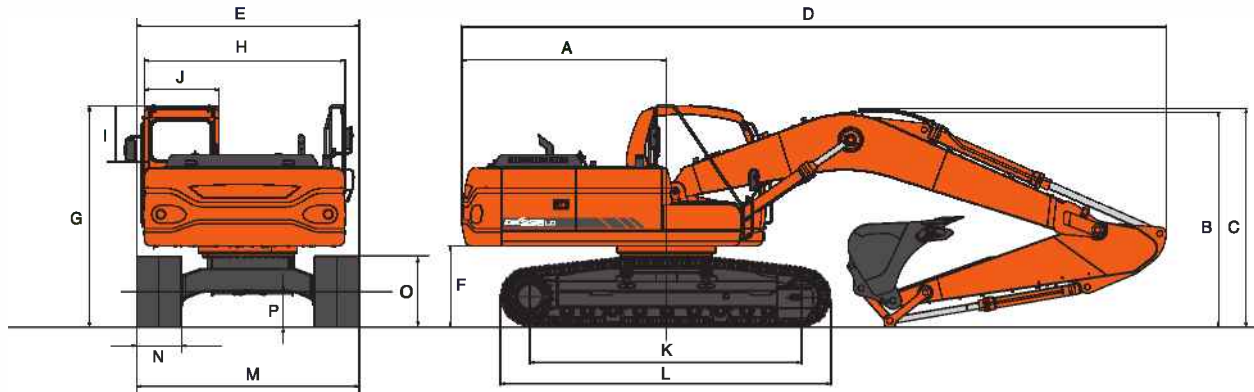

BOOM TYPE		18'8" (5,700 mm)		
ARM TYPE		7'10" (2,400 mm)	9'6" (2,900 mm)	11'6" (3,500 mm)
BUCKET TYPE (SAE)		1.37 yd ³ (1.05 m ³)	1.20 yd ³ (0.92 m ³)	1.06 yd ³ (0.81 m ³)
TAIL SWING RADIUS	A	→	9' (2,750 mm)	←
SHIPPING HEIGHT (BOOM)	B	10' (3,045 mm)	9'8" (2,940 mm)	10'7" (3,225 mm)
SHIPPING HEIGHT (HOSE)	C	10'2" (3,110 mm)	9'10" (3,005 mm)	10'10" (3,290 mm)
SHIPPING LENGTH	D	31'2" (9,500 mm)	31'1" (9,485 mm)	31'2" (9,500 mm)
SHIPPING WIDTH	E	10'6" (3,190 mm)	10'6" (3,190 mm)	10'10" (3,290 mm)
C/WEIGHT CLEARANCE	F	→	3'6" (1,055 mm)	←
HEIGHT OVER CABIN	G	→	9'9" (2,975 mm)	←
HOUSE WIDTH	H	→	8'11" (2,710 mm)	←
CABIN HEIGHT ABOVE HOUSE	I	→	2'9" (845 mm)	←
CABIN WIDTH	J	→	3'2" (960 mm)	←
TUMBLER DISTANCE	K	→	12' (3,650 mm)	←
TRACK LENGTH	L	→	14'7" (4,445 mm)	←
UNDERCARRIAGE WIDTH	M	→	9'10" (2,990 mm)	←
SHOE WIDTH	N	2'7" (800 mm)	2'7" (800 mm)	2'11" (900 mm)
TRACK HEIGHT	O	→	3'1" (947 mm)	←
CAR BODY CLEARANCE	P	→	1'7" (480 mm)	←



WORKING RANGE

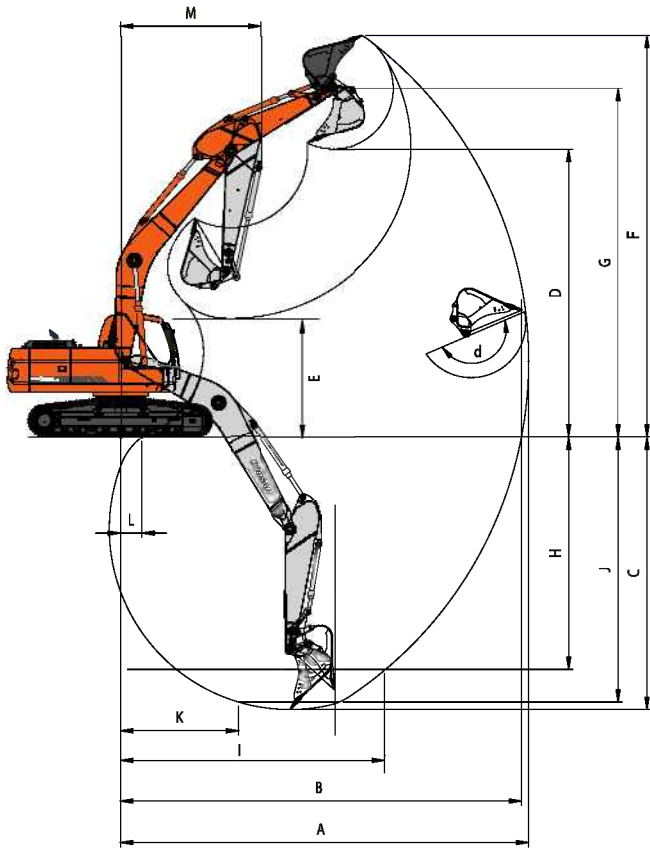

BOOM TYPE		18'8" (5,700 mm)		
ARM TYPE		7'10" (2,400 mm)	9'6" (2,900 mm)	11'6" (3,500 mm)
BUCKET TYPE (SAE)		1.37 yd ³ (1.05 m ³)	1.20 yd ³ (0.92 m ³)	1.06 yd ³ (0.81 m ³)
MAX. DIGGING REACH	A	31'1" (9,480 mm)	32'6" (9,900 mm)	33'11" (10,340 mm)
MAX. DIGGING REACH (GROUND)	B	30'6" (9,300 mm)	31'11" (9,730 mm)	33'7" (10,230 mm)
MAX. DIGGING DEPTH	C	20'1" (6,110 mm)	21'9" (6,620 mm)	23'8" (7,220 mm)
MAX. LOADING HEIGHT	D	22'5" (6,830 mm)	22'11" (6,990 mm)	23'5" (7,150 mm)
MIN. LOADING HEIGHT	E	10'1" (3,070 mm)	8'5" (2,555 mm)	6'5" (1,953 mm)
MAX. DIGGING HEIGHT	F	31'7" (9,630 mm)	32' (9,750 mm)	32'5" (9,870 mm)
MAX. BUCKET PIN HEIGHT	G	27'3" (8,299 mm)	27'9" (8,450 mm)	28'3" (8,612 mm)
MAX. VERTICAL WALL DEPTH	H	17'8" (5,390 mm)	18'6" (5,640 mm)	19'9" (6,010 mm)
MAX. RADIUS VERTICAL	I	19'10" (6,050 mm)	21' (6,410 mm)	22'2" (6,750 mm)
MAX. DEPTH TO 8' LINE	J	19'5" (5,910 mm)	21'1" (6,430 mm)	23'2" (7,050 mm)
MIN. RADIUS 8' LINE	K	9'5" (2,880 mm)	9'5" (2,865 mm)	9'3" (2,830 mm)
MIN. DIGGING REACH	L	5'7" (1,698 mm)	1'8" (519 mm)	-9" (-224 mm)
MIN. SWING RADIUS	M	11'2" (3,410 mm)	11'2" (3,410 mm)	11'3" (3,440 mm)
BUCKET ANGLE (DEG)	d	166°	166°	166°

STANDARD EQUIPMENT

ENGINE

DOOSAN DLo6; Turbo Charged and Aftercooled
Electronically Controlled Common Rail Direct Injected
359 in³ (5,890 cc), 6 Cylinder
148 hp (110 kW) SAE Net Flywheel Horsepower @ 1,900 rpm
Auto Idle System
Equipped with the Fuel Prefilter with Water Separator and Built in Priming Pump
Radiator Reserve Tank
Large Capacity Double Element Air Cleaner with Evacuator
Electronic Engine Speed Control
Engine Overheat and Low Oil Pressure Prevention System

HYDRAULIC SYSTEM

Pilot Operated Control Valves, (9) Spools
Main Pump:
Tandem Variable Axial Piston Type, Pressure Setting 4,978 psi (343 bar)
Pilot Circuit:
– Gear Type Pump
Swing Motor:
– Axial Piston Type
– Swing Speed Control up to 11 rpm
– Spring Set, Hydraulic-released Brakes
Travel Motor:
– Axial Piston Type, Automatic 2-Speed Control
Travel Speed (High/Low):
– 3.4/1.9 MPH (5.5/3.0 km/h)
In-Shoe Design, Oil Disk Parking Brake
Cross Sensing Pump Control for Fuel Saving
Two Operating Modes, Two Power Modes
Button Control of Flow in Auxiliary Equipment Circuits
Computer-aided Pump Power Control
e-EPOS (Electronic Power Optimizing System) Controller

CABIN

Steel, All Weather Sound Suppressed Type
Fully Automatic Controlled Air Conditioner with Heat
Multifunction Color LCD Monitor Panel
Lighter with Ashtray
Door Locks
Front Windshield Wiper with Washer
Radio:
– AM/FM Stereo with Cassette
– Remote Radio On/Off Switch, Control Volume, Channel Selection
Switches:
– Auxiliary Mode Switch
– Engine Emergency Stop Switch
– Work Light Switch
– Travel Speed Selector Switch
– Breaker, Power-up, Shear Switch
Glass Antenna
Safety Glass, Tinted
Safety Lock Lever
Seat:
– Suspension with Seat Belt (2 Wide)
– Reclining, Height Adjustable
– Adjustable Arm Rests
– Sliding Control Console
– Weight Adjustment Knob
Skylight
Pull Up Type Front Window
Removable Lower Front Window
Sliding Side Windows
Front Window Air Defroster
Travel Pedals with Hand Levers
Emergency Breakout Tool
Lunch Box with Hot and Cool Air



STANDARD EQUIPMENT (CONT'D)

12V Power Socket
Joystick Lever with 3 Switches
Cup Holder
Room Light
Serial Communication Port for Laptop PC Interface (DMS, E-Doctor)
Viscous Cabin Mounts

ELECTRICAL

Alternator:

- 60 amp

Batteries:

- (2) 12 Volt, 100 amp Hr. 750 CCA each

Starter:

- 24 Volt, 4.5 kW

Lights:

- Halogen Working Light (2) Machine, (2) Boom

Electric Horn

Hour Meter

Alarm Buzzer for:

- Engine Oil Pressure
- Coolant Temperature

Electronic Monitor for:

- Engine Coolant Temperature Gauge
- Fuel Gauge
- Hydraulic Oil Temperature Gauge

Multifunction Display for:

- Engine rpm
- Battery Voltage
- Front and Rear Hydraulic Pump Pressure
- Hydraulic Oil Overheating Warning
- Fuel Shortage Warning
- Air Cleaner Clogging Warning
- Pilot Filter Clogging Warning
- Return Filter Clogging Warning
- Digital Clock
- Engine Check Warning Light
- Engine Oil Pressure Warning Light
- Charge Warning Light
- Preheat Indicator Light
- Coolant Temperature Warning Light
- Work Light Indicator Light

Operation Modes for:

- Power Mode Selector Button
- Flow Rate Control
- Auto Idle Selector Button
- 4 Display Selector Buttons
- Trenching Mode Selector Button

UNDERCARRIAGE

Track Guards and Chains with Adjusters

Track Rollers:

- (2) Upper, (9) Lower Each Side

Triple Grouser Shoes, 49 Each Side; 31.5" (800 mm) Width

OTHER STANDARD EQUIPMENT

Joystick Pattern Change Valve

Counterweight:

- 9,040 lb (4,100 kg)

Sealed Pins, Boom, Arm and Bucket Linkages

Swing Mechanism, Internal Gear and Pinion

Integrated Track Spring and Idler

Centralized Lube Points

Large Handrail

Punched Metal Anti-slip Plates

Ultra-hard Wear-resistant Disk at the Bucket Pivot

Engine Restart Prevention System

Self-Diagnostic System

Manuals, Parts and Operator's

GPS 1 Year Subscription

OPTIONAL EQUIPMENT

HYDRAULIC KITS – FACTORY INSTALLED

Boom Arm Lock Valve w/Piping
Single Acting Breaker Kit
Double Acting Thumb Kit

ADDITIONAL OPTIONS – FACTORY INSTALLED

Air Suspension Seat
CD Player
Work Light (2 Front Mounted on Cabin)
Work Lights (4 Front 2 Rear Mounted on Cabin)
Rotating Beacon (Mounted on Cabin)
24 V, 80 amps Alternator
Swing Alarm
Electric Fuel Supply Pump
Heavier Counterweight
Rain Shield
Falling Objects Guard Assembly Kit
Lock Valve

GEITH COUPLERS – DEALER INSTALLED

Hydraulic Quick Coupler
Manual Quick Coupler

GEITH THUMBS – DEALER INSTALLED

Hydraulic Pro Link Thumb
Mechanical Thumb

HYDRAULIC KITS – DEALER INSTALLED

Breaker Kit (B) Single Acting HKX
Thumb Kit (T) Double Acting HKX Piping Ends at Boom Tip
Breaker / Thumb (BT) Single and Double Acting HKX

ADDITIONAL OPTIONS – DEALER INSTALLED

3" (76 mm) Seat Belt
Vandalism Covers



LIFTING CAPACITY

Boom: 18'8" (5,700 mm)

Arm: 9'6" (2,900 mm)

Bucket: SAE 1.20 yd³ (0.92 m³)

Shoe: 31.5" (800 mm)

Counterweight: 4.52 ton (4.1 metric ton)

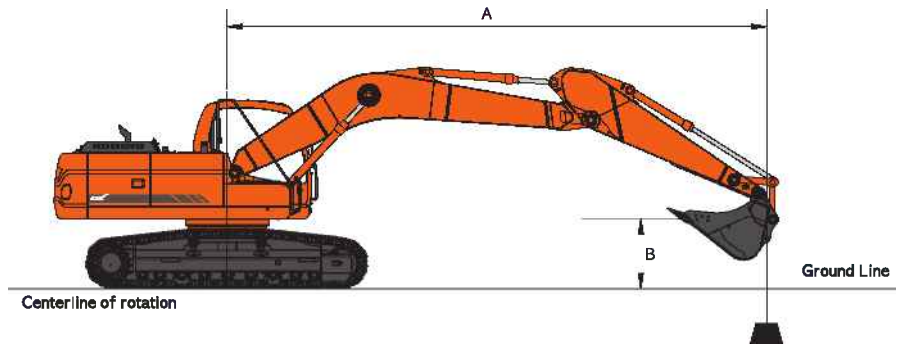

Feet

Unit: 1,000 lb

B (ft)	A (ft) 10		15		20		25		MAX. REACH		A (ft)
25					7.41 *	7.41 *			6.38 *	6.38 *	20.78
20					9.15 *	9.15 *			6.02 *	6.02 *	24.46
15					10.15 *	10.15 *	9.03 *	7.06	6.05 *	6.05 *	26.74
10	23.40 *	23.40 *	15.02 *	15.02 *	11.75 *	9.88	10.10 *	6.78	6.37 *	5.53	27.94
5	17.45 *	17.45 *	18.39 *	14.34	13.43 *	9.25	10.72	6.47	7.01 *	5.26	28.20
0 (GROUND)	18.94 *	18.94 *	20.33 *	13.52	14.61 *	8.78	10.46	6.23	8.14 *	5.33	27.56
-5	25.54 *	25.54 *	20.53 *	13.23	14.59	8.56	10.35	6.13	9.80	5.80	25.94
-10	27.48 *	26.54	19.02 *	13.32	13.85 *	8.60			11.26 *	6.96	23.14
-15	21.37 *	21.37 *	15.14 *	13.79					11.49 *	9.99	18.60

Metric

Unit: 1,000 kg

B (m)	A (m) 2		3		4		5		6		7		8		MAX. REACH		A (m)
8															2.98 *	2.98 *	5.95
7															2.80 *	2.80 *	6.86
6									4.18 *	4.18 *	3.82 *	3.82 *			2.73 *	2.73 *	7.51
5									4.46 *	4.46 *	4.27 *	3.78			2.73 *	2.73 *	7.99
4							5.47 *	5.47 *	4.90 *	4.78	4.53 *	3.68	3.77 *	2.89	2.78 *	2.67	8.32
3			10.98 *	10.98 *	7.85 *	7.85 *	6.32 *	6.14	5.42 *	4.59	4.85 *	3.55	4.46 *	2.82	2.89 *	2.50	8.52
2			8.63 *	8.63 *	9.27 *	8.20	7.16 *	5.82	5.95 *	4.39	5.18 *	3.43	4.53	2.74	3.07 *	2.41	8.60
1			7.33 *	7.33 *	10.29 *	7.77	7.86 *	5.55	6.42 *	4.21	5.48 *	3.32	4.46	2.67	3.33 *	2.38	8.56
0 (GROUND)	4.95 *	4.95 *	8.35 *	8.35 *	10.79 *	7.53	8.31 *	5.36	6.74 *	4.08	5.42	3.23	4.40	2.61	3.69 *	2.42	8.40
-1	7.23 *	7.23 *	10.18 *	10.18 *	10.85 *	7.43	8.47 *	5.26	6.81	4.00	5.35	3.17	4.37	2.59	4.23 *	2.53	8.11
-2	9.48 *	9.48 *	12.58 *	12.25	10.54 *	7.42	8.35 *	5.22	6.78	3.97	5.34	3.15			4.64	2.75	7.68
-3	11.99 *	11.99 *	12.69 *	12.39	9.86 *	7.49	7.90 *	5.25	6.43 *	3.99	5.21 *	3.19			5.10 *	3.13	7.09
-4	14.69 *	14.69 *	11.06 *	11.06 *	8.74 *	7.62	7.02 *	5.35	5.60 *	4.08					5.21 *	3.83	6.27
-5			8.66 *	8.66 *	6.91 *	6.91 *	5.39 *	5.39 *							5.16 *	5.16 *	5.14

1. LOAD POINT IS THE END OF THE ARM.

2. CAPACITIES MARKED WITH AN ASTERISK (*) ARE LIMITED BY HYDRAULIC CAPACITIES.

3. LIFT CAPACITIES SHOWN DO NOT EXCEED 75% OF MINIMUM TIPPING LOADS OR 87% OF HYDRAULIC CAPACITIES.

Rating Over Front

Rating Over Side or 360 degree

DX225LC

Boom: 18'8" (5,700 mm)
Arm: 11'6" (3,500 mm)
Bucket: SAE 1.06 yd³ (0.81 m³)
Shoe: 35.4" (900 mm)
Counterweight: 4.52 ton (4.1 metric ton)

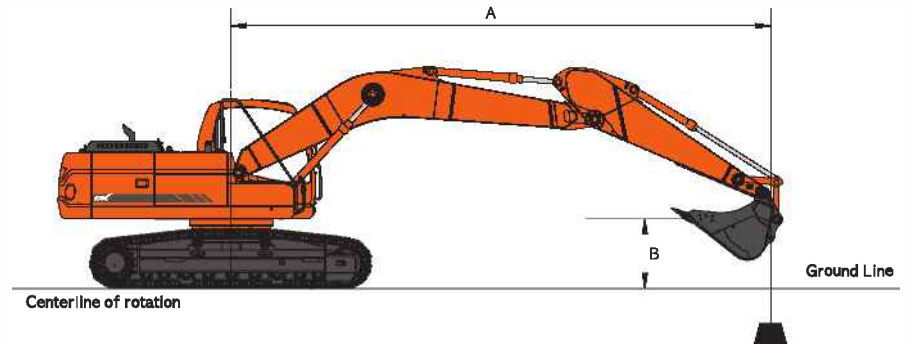

Feet Unit: 1,000 lb

B (ft) \ A (ft)	10		15		20		25		MAX. REACH		A (ft)
25									5.44 *	5.44 *	22.79
20							6.57 *	6.57 *	5.18 *	5.18 *	26.19
15					9.02 *	9.02 *	8.50 *	7.23	5.21 *	5.21 *	28.32
10			13.28 *	13.28 *	10.70 *	10.12	9.32 *	6.90	5.48 *	5.07	29.45
5	25.91 *	25.91 *	16.97 *	14.73	12.54 *	9.41	10.27 *	6.53	6.01 *	4.81	29.71
0 (GROUND)	20.98 *	20.98 *	19.50 *	13.69	14.00 *	8.84	10.52	6.22	6.92 *	4.84	29.10
-5	25.06 *	25.06 *	20.35 *	13.21	14.64	8.51	10.33	6.05	8.51 *	5.20	27.57
-10	29.10 *	26.21	19.54 *	13.16	14.18 *	8.45			10.39	6.09	24.95
-15	24.14 *	24.14 *	16.71 *	13.48	11.84 *	8.70			11.08 *	8.22	20.82
-20									10.92 *	10.92 *	13.91

Metric Unit: 1,000 kg

B (m) \ A (m)	2		3		4		5		6		7		8		9		MAX. REACH		A (m)
8																	2.53 *	2.53 *	6.61
7											3.04 *	3.04 *					2.40 *	2.40 *	7.42
6											3.64 *	3.64 *	2.41 *	2.41 *			2.35 *	2.35 *	8.03
5											3.83 *	3.83 *	3.25 *	3.02			2.35 *	2.35 *	8.48
4								4.38 *	4.38 *	4.11 *	3.76	3.86 *	2.95				2.40 *	2.40 *	8.79
3			9.07 *	9.07 *	6.83 *	6.83 *	5.65 *	5.65 *	4.93 *	4.70	4.46 *	3.63	4.13 *	2.86			2.49 *	2.29	8.98
2			11.98 *	11.98 *	8.36 *	8.36 *	6.56 *	5.98	5.51 *	4.48	4.83 *	3.48	4.37 *	2.77	2.83 *	2.23	2.63 *	2.21	9.06
1			9.54 *	9.54 *	9.61 *	7.97	7.37 *	5.66	6.04 *	4.27	5.19 *	3.35	4.50	2.68	2.92 *	2.18	2.85 *	2.17	9.02
0 (GROUND)	5.58 *	5.58 *	9.25 *	9.25 *	10.39 *	7.63	7.96 *	5.42	6.46 *	4.11	5.46	3.23	4.42	2.61			3.14 *	2.19	8.87
-1	7.18 *	7.18 *	10.31 *	10.31 *	10.71 *	7.45	8.28 *	5.27	6.71 *	4.00	5.37	3.15	4.36	2.56			3.56 *	2.28	8.60
-2	8.95 *	8.95 *	12.05 *	12.05 *	10.64 *	7.38	8.33 *	5.19	6.77 *	3.93	5.33	3.11	4.35	2.54			4.19	2.45	8.19
-3	10.97 *	10.97 *	13.44 *	12.24	10.20 *	7.40	8.07 *	5.19	6.57 *	3.93	5.33	3.12					4.68	2.74	7.64
-4	13.37 *	13.37 *	12.12 *	12.12 *	9.35 *	7.49	7.46 *	5.25	6.04 *	3.98							4.94 *	3.25	6.89
-5	13.75 *	13.75 *	10.16 *	10.16 *	7.96 *	7.68	6.32 *	5.39									5.07 *	4.23	5.88
-6					5.63 *	5.63 *											4.99 *	4.99 *	4.41

- LOAD POINT IS THE END OF THE ARM.
- CAPACITIES MARKED WITH AN ASTERISK (*) ARE LIMITED BY HYDRAULIC CAPACITIES.
- LIFT CAPACITIES SHOWN DO NOT EXCEED 75% OF MINIMUM TIPPING LOADS OR 87 % OF HYDRAULIC CAPACITIES.

Rating Over Front
 Rating Over Side or 360 degree



LIFTING CAPACITY

Boom: 27'11" (8,500 mm)

Arm: 20'4" (6,200 mm)

Bucket: SAE 0.51 yd³ (0.39 m³)

Shoe: 35.4" (900 mm)

Counterweight: 4.52 ton (4.1 metric ton)

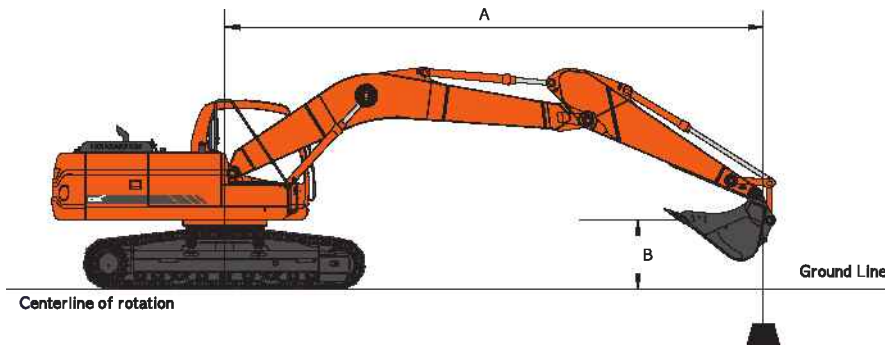

Feet

B (ft)	A (ft)		15	
	10	15	10	15
35				
30				
25				
20				
15				
10				
5				
0 (GROUND)	11.15 *	11.15 *	14.30 *	13.61
-5	10.79 *	10.79 *	16.99 *	11.00
-10	12.49 *	12.49 *	17.65 *	10.64
-15	14.52 *	14.52 *	17.62 *	10.6
-20	16.86 *	16.86 *	16.57 *	10.79
-25	19.58 *	19.58 *	14.82 *	11.17
-30	16.67 *	16.67 *	12.15 *	11.77
-35				















Metric

B (m)	A (m)		3		4		5		6		7		8	
	2	3	2	3	2	3	2	3	2	3	2	3	2	3
12														
11														
10														
9														
8														
7														
6														
5														
4													2.67 *	2.67 *
3									3.82 *	3.82 *	3.32 *	3.32 *	2.96 *	2.96 *
2			5.98 *	5.98 *	7.16 *	7.16 *	5.42 *	5.42 *	4.39 *	4.35	3.72 *	3.43	3.25 *	2.77
1			4.43 *	4.43 *	7.92 *	7.06	6.16 *	5.17	4.91 *	3.99	4.10 *	3.18	3.53 *	2.58
0 (GROUND)	3.21 *	3.21 *	4.33 *	4.33 *	6.54 *	6.51	6.74 *	4.76	5.35 *	3.70	4.43 *	2.96	3.79 *	2.42
-1	3.75 *	3.75 *	4.62 *	4.62 *	6.29 *	6.19	7.12 *	4.48	5.67 *	3.47	4.69 *	2.78	4.00 *	2.28
-2	4.30 *	4.30 *	5.06 *	5.06 *	6.47 *	6.03	7.34 *	4.31	5.89 *	3.31	4.83	2.65	3.96	2.17
-3	4.86 *	4.86 *	5.59 *	5.59 *	6.87 *	5.96	7.41 *	4.21	5.99	3.21	4.73	2.56	3.87	2.09
-4	5.45 *	5.45 *	6.18 *	6.18 *	7.42 *	5.96	7.36 *	4.17	5.93	3.16	4.67	2.51	3.82	2.04
-5	6.05 *	6.05 *	6.82 *	6.82 *	8.08 *	6.01	7.20 *	4.18	5.92	3.15	4.65	2.49	3.79	2.02
-6	6.70 *	6.70 *	7.53 *	7.53 *	8.58 *	6.10	6.92 *	4.23	5.74 *	3.17	4.66	2.49	3.80	2.03
-7	7.38 *	7.38 *	8.30 *	8.30 *	8.01 *	6.23	6.52 *	4.31	5.44 *	3.23	4.63 *	2.53	3.83	2.06
-8	8.10 *	8.10 *	9.16 *	9.16 *	7.26 *	6.40	5.97 *	4.43	5.02 *	3.31	4.27 *	2.60	3.66 *	2.12
-9	8.87 *	8.87 *	7.87 *	7.87 *	6.30 *	6.30 *	5.23 *	4.59	4.42 *	3.44	3.75 *	2.71	3.18 *	2.21
-10			6.17 *	6.17 *	5.05 *	5.05 *	4.23 *	4.23 *	3.57 *	3.57 *	2.98 *	2.86		















1. LOAD POINT IS THE END OF THE ARM.
2. CAPACITIES MARKED WITH AN ASTERISK (*) ARE LIMITED BY HYDRAULIC CAPACITIES.
3. LIFT CAPACITIES SHOWN DO NOT EXCEED 75% OF MINIMUM TIPPING LOADS OR 87% OF HYDRAULIC CAPACITIES.

DX225LC

Unit: 1,000 lb

20		25		30		35		40		45		MAX. REACH		A (ft)
														
						2.06 *	2.06 *					1.03 *	1.03 *	36.92
						3.23 *	3.23 *	1.18 *	1.18 *			0.94 *	0.94 *	40.38
						3.94 *	3.94 *	2.58 *	2.58 *			0.89 *	0.89 *	42.97
						4.38 *	4.38 *	3.45 *	3.23			0.88 *	0.88 *	44.87
				5.15 *	5.15 *	4.75 *	4.15	4.19 *	3.07	1.79 *	1.79 *	0.91 *	0.91 *	46.13
8.24 *	8.24 *	6.76 *	6.76 *	5.83 *	5.18	5.20 *	3.85	4.76 *	2.88	2.42 *	2.14	0.96 *	0.96 *	46.83
10.06 *	8.99	7.86 *	6.39	6.54 *	4.72	5.67 *	3.55	4.92	2.68	2.77 *	2.02	1.05 *	1.05 *	46.98
11.56 *	7.97	8.83 *	5.75	7.19 *	4.30	5.92	3.27	4.72	2.50	2.75 *	1.90	1.19 *	1.19 *	46.60
12.54 *	7.29	9.51	5.27	7.22	3.96	5.68	3.04	4.56	2.35	2.14 *	1.82	1.38 *	1.38 *	45.67
12.88	6.91	9.18	4.96	6.98	3.73	5.51	2.88	4.46	2.25			1.65 *	1.65 *	44.15
12.73	6.78	9.02	4.82	6.85	3.62	5.43	2.8	4.43	2.22			2.06 *	2.05	41.96
12.39 *	6.83	9.02	4.82	6.85	3.62	5.45	2.82					2.70 *	2.38	39.04
11.27 *	7.04	8.86 *	4.97	6.99	3.74	4.23 *	2.98					3.85 *	2.97	35.14
9.36 *	7.44	7.28 *	5.29									5.45 *	4.08	29.93
6.04 *	6.04 *											5.07 *	5.07 *	22.43

Unit: 1,000 kg

9		10		11		12		13		14		MAX. REACH		A (m)
														
		0.57 *	0.57 *									0.53 *	0.53 *	10.06
												0.48 *	0.48 *	10.97
				1.03 *	1.03 *							0.45 *	0.45 *	11.75
				1.37 *	1.37 *	0.78 *	0.78 *					0.42 *	0.42 *	12.39
				1.62 *	1.62 *	1.17 *	1.17 *					0.41 *	0.41 *	12.92
				1.82 *	1.82 *	1.44 *	1.44 *	0.77 *	0.77 *			0.40 *	0.40 *	13.35
		2.03 *	2.03 *	1.98 *	1.86	1.68 *	1.52	1.09 *	1.09 *			0.40 *	0.40 *	13.70
2.27 *	2.27 *	2.17 *	2.17 *	2.08 *	1.79	1.90 *	1.47	1.33 *	1.20			0.41 *	0.41 *	13.97
2.47 *	2.47 *	2.32 *	2.09	2.19 *	1.72	2.09 *	1.41	1.54 *	1.16	0.62 *	0.62 *	0.42 *	0.42 *	14.16
2.69 *	2.41	2.48 *	1.98	2.31 *	1.64	2.18 *	1.35	1.73 *	1.12	0.79 *	0.79 *	0.44 *	0.44 *	14.28
2.91 *	2.27	2.65 *	1.87	2.44 *	1.55	2.28 *	1.29	1.89 *	1.07	0.90 *	0.88	0.46 *	0.46 *	14.32
3.12 *	2.13	2.81 *	1.77	2.57 *	1.47	2.26	1.23	1.96	1.02	0.92 *	0.85	0.50 *	0.50 *	14.30
3.32 *	2.00	2.96 *	1.67	2.55	1.40	2.20	1.17	1.91	0.98	0.85 *	0.82	0.54 *	0.54 *	14.20
3.41	1.89	2.89	1.58	2.48	1.33	2.15	1.12	1.87	0.95	0.66 *	0.66 *	0.59 *	0.59 *	14.04
3.32	1.80	2.82	1.51	2.43	1.28	2.11	1.08	1.84	0.92			0.66 *	0.66 *	13.79
3.24	1.74	2.76	1.46	2.38	1.24	2.08	1.05	1.62 *	0.9			0.74 *	0.74 *	13.47
3.20	1.70	2.73	1.43	2.36	1.21	2.06	1.04	1.00 *	0.9			0.86 *	0.86 *	13.06
3.18	1.68	2.71	1.41	2.35	1.20	2.06	1.04					1.00 *	0.96	12.57
3.18	1.68	2.72	1.42	2.36	1.22							1.20 *	1.07	11.96
3.21	1.71	2.75	1.45	2.22 *	1.26							1.49 *	1.22	11.23
3.14 *	1.77	2.65 *	1.51									1.95 *	1.44	10.37
2.64 *	1.86											2.47 *	1.78	9.30
												2.42 *	2.38	7.96

 Rating Over Front

 Rating Over Side or 360 degree



Boom: 18'8" (5,700 mm)
Arm: 9'6" (2,900 mm)
Bucket: SAE 1.20 yd³ (0.92 m³)
Shoe: 19.7" (500 mm)
Counterweight: 4.52 ton (4.1 metric ton)

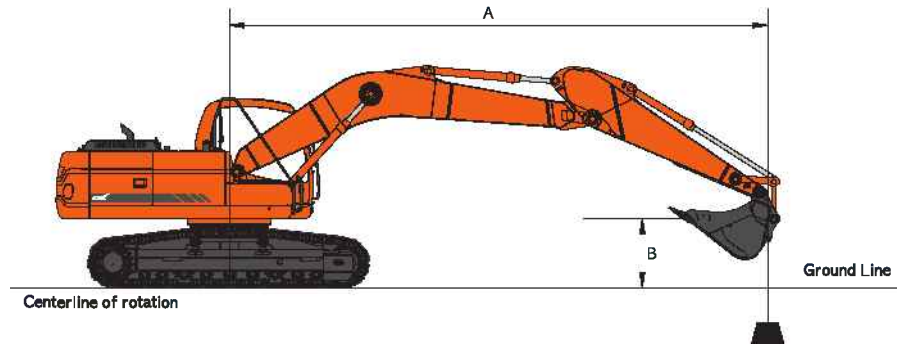

Feet Unit: 1,000 lb

B (ft) \ A (ft)	10		15		20		25		MAX. REACH		A (ft)
25					7.41 *	7.41 *			6.38 *	6.38 *	20.78
20					9.15 *	9.15 *			6.02 *	6.02 *	24.46
15					10.15 *	10.00	9.03 *	6.69	6.05 *	5.85	26.74
10	23.40 *	23.40 *	15.02 *	14.95	11.75 *	9.39	10.10 *	6.41	6.37 *	5.21	27.94
5	17.45 *	17.45 *	18.39 *	13.63	13.43 *	8.76	10.13	6.10	7.01 *	4.94	28.20
0 (GROUND)	18.94 *	18.94 *	20.33 *	12.81	14.04	8.29	9.86	5.86	8.14 *	5.00	27.56
-5	25.54 *	24.79	20.53 *	12.52	13.79	8.07	9.75	5.76	9.23	5.45	25.94
-10	27.48 *	25.21	19.02 *	12.61	13.83	8.11			11.07	6.56	23.14
-15	21.37 *	21.37 *	15.14 *	13.07					11.49 *	9.45	18.60

Metric Unit: 1,000 kg

B (m) \ A (m)	2		3		4		5		6		7		8		MAX. REACH		A (m)
8															2.98 *	2.98 *	5.95
7															2.80 *	2.80 *	6.86
6									4.18 *	4.18 *	3.82 *	3.65			2.73 *	2.73 *	7.51
5									4.46 *	4.46 *	4.27 *	3.59			2.73 *	2.73 *	7.99
4							5.47 *	5.47 *	4.90 *	4.56	4.53 *	3.49	3.77 *	2.73	2.78 *	2.52	8.32
3			10.98 *	10.98 *	7.85 *	7.85 *	6.32 *	5.86	5.42 *	4.36	4.85 *	3.37	4.36	2.66	2.89 *	2.36	8.52
2			8.63 *	8.63 *	9.27 *	7.80	7.16 *	5.53	5.95 *	4.16	5.18 *	3.24	4.28	2.58	3.07 *	2.26	8.60
1			7.33 *	7.33 *	10.29 *	7.38	7.86 *	5.26	6.42 *	3.99	5.21	3.13	4.20	2.51	3.33 *	2.23	8.56
0 (GROUND)	4.95 *	4.95 *	8.35 *	8.35 *	10.79 *	7.14	8.31 *	5.08	6.53	3.85	5.11	3.04	4.14	2.46	3.69 *	2.27	8.40
-1	7.23 *	7.23 *	10.18 *	10.18 *	10.85 *	7.04	8.47 *	4.97	6.44	3.77	5.05	2.98	4.11	2.43	4.03	2.38	8.11
-2	9.48 *	9.48 *	12.58 *	11.63	10.54 *	7.03	8.35 *	4.94	6.40	3.74	5.03	2.97			4.38	2.59	7.68
-3	11.99 *	11.99 *	12.69 *	11.78	9.86 *	7.09	7.90 *	4.97	6.43	3.76	5.07	3			4.98	2.95	7.09
-4	14.69 *	14.69 *	11.06 *	11.06 *	8.74 *	7.23	7.02 *	5.07	5.60 *	3.86					5.21 *	3.62	6.27
-5			8.66 *	8.66 *	6.91 *	6.91 *	5.39 *	5.27							5.16 *	5.05	5.14

1. LOAD POINT IS THE END OF THE ARM.
 2. CAPACITIES MARKED WITH AN ASTERISK (*) ARE LIMITED BY HYDRAULIC CAPACITIES.
 3. LIFT CAPACITIES SHOWN DO NOT EXCEED 75% OF MINIMUM TIPPING LOADS OR 87% OF HYDRAULIC CAPACITIES.

Rating Over Front
 Rating Over Side or 360 degree



35a Bonnyside Road, Bonnybridge FK4 2AD

T: 01324 815 055

M: 07793 184 825

E: info@mcinallyplant.com

www.mcinallyplant.com

BRO-DX225LC-TD

Kn-2M-1210-24171-3-F

For more information visit www.doosanequipment.com



Doosan® is a registered trademark of Doosan Infracore Co., Ltd. in the United States.

© 2010 Doosan Infracore Construction Equipment America. All rights reserved.